



W|O|W

FLOOR TILES

*perfect floors for unique spaces*



WOW

FLOOR TILES

—  
*perfect floors for unique spaces*

perfect floors for unique spaces

# FLOOR TILES

WOW





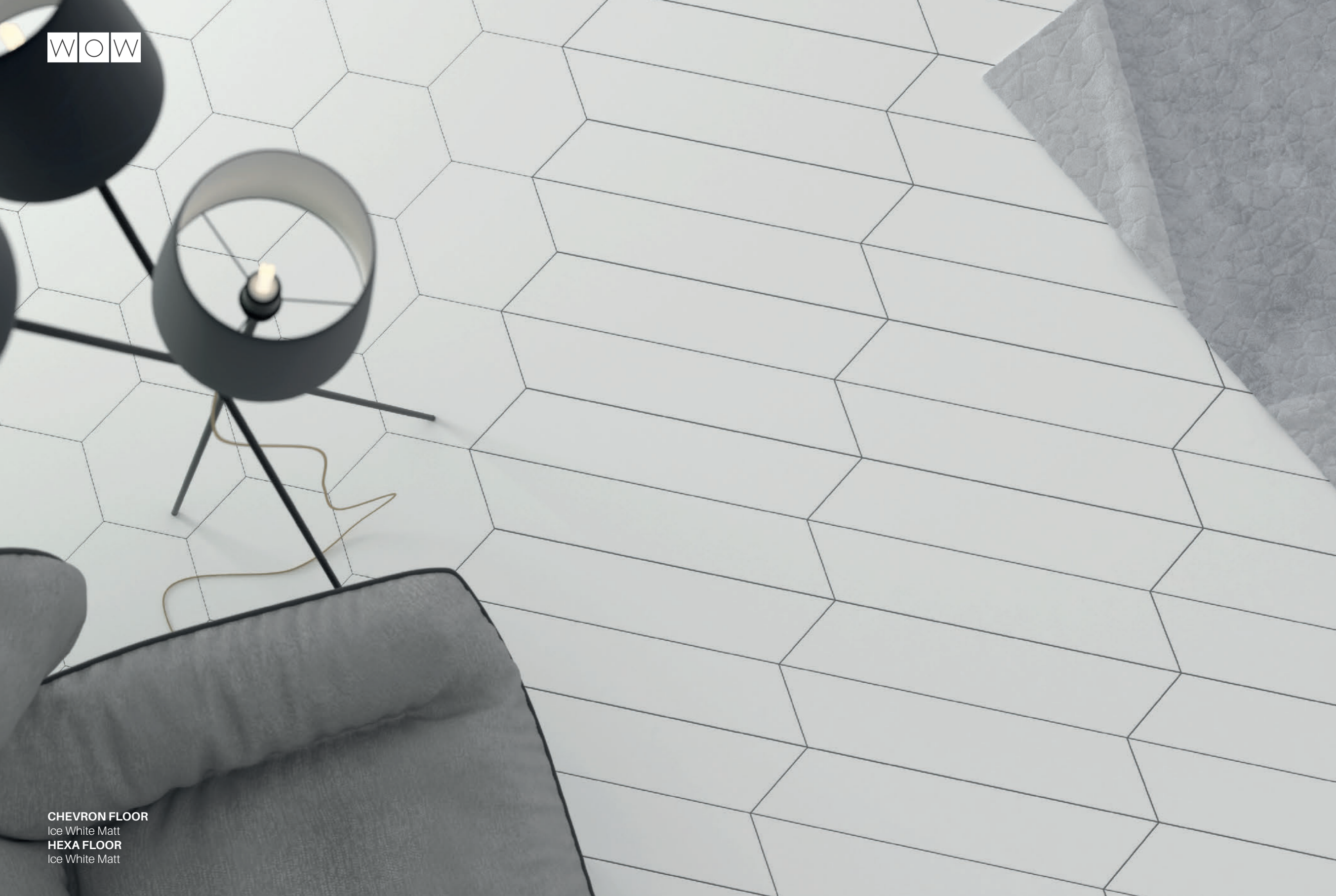

**CHEVRON FLOOR**  
Ice White Matt  
**HEXA FLOOR**  
Ice White Matt

06

Introduction / introducción

08

Triangle Floor  
8"x9" / 20X23 cm

18

Hexa Floor  
8"x9" / 20X23 cm

28

Trapezium Floor  
4"x9" / 10X23 cm

42

Chevron Floor  
8"x20,5" / 10X52 cm

56

Technical features / Información técnica



# four models

infinity solutions

Choosing the right floor can prove challenging...  
We present you four shapes: Trapezium, Hexa, Triangle and Chevron.  
Modular to combine between them.  
Each one in three colours.

Elegir el pavimento adecuado puede ser un reto...  
Te presentamos cuatro formas distintas: Trapezium, Hexa, Triangle and Chevron.  
Cada una disponible en tres colores.  
¿Quieres ver nuestra propuesta?



**TRAPEZIUM FLOOR**  
4"x9" / 10x23 cm



**HEXA FLOOR**  
8"x9" / 20x23 cm



**TRIANGLE FLOOR**  
8"x9" / 20x23 cm



**CHEVRON FLOOR**  
4"x20,5" / 10x52 cm

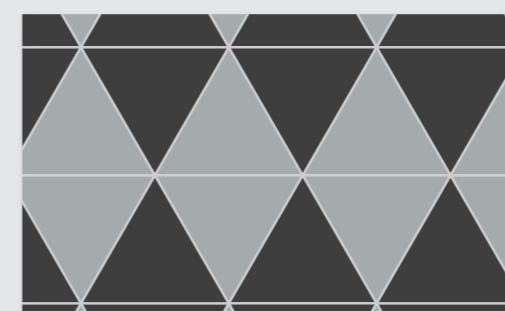
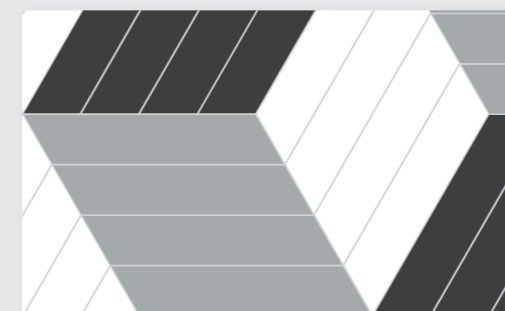
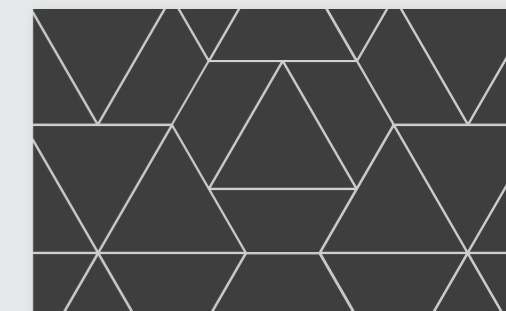

**COLOUR COMBINATIONS**  
combinaciones de color

**UNLIMITED COMPOSITIONS**  
composiciones infinitas

**MIXED FORMATS**  
combinación de formatos

# TRIANGLE FLOOR

8"X9" / 20X23 cm



Available colours / Colores disponibles



ICE WHITE MATT

ASH GREY MATT

GRAPHITE MATT



TRIANGLE FLOOR  
Ice White Matt



WOW

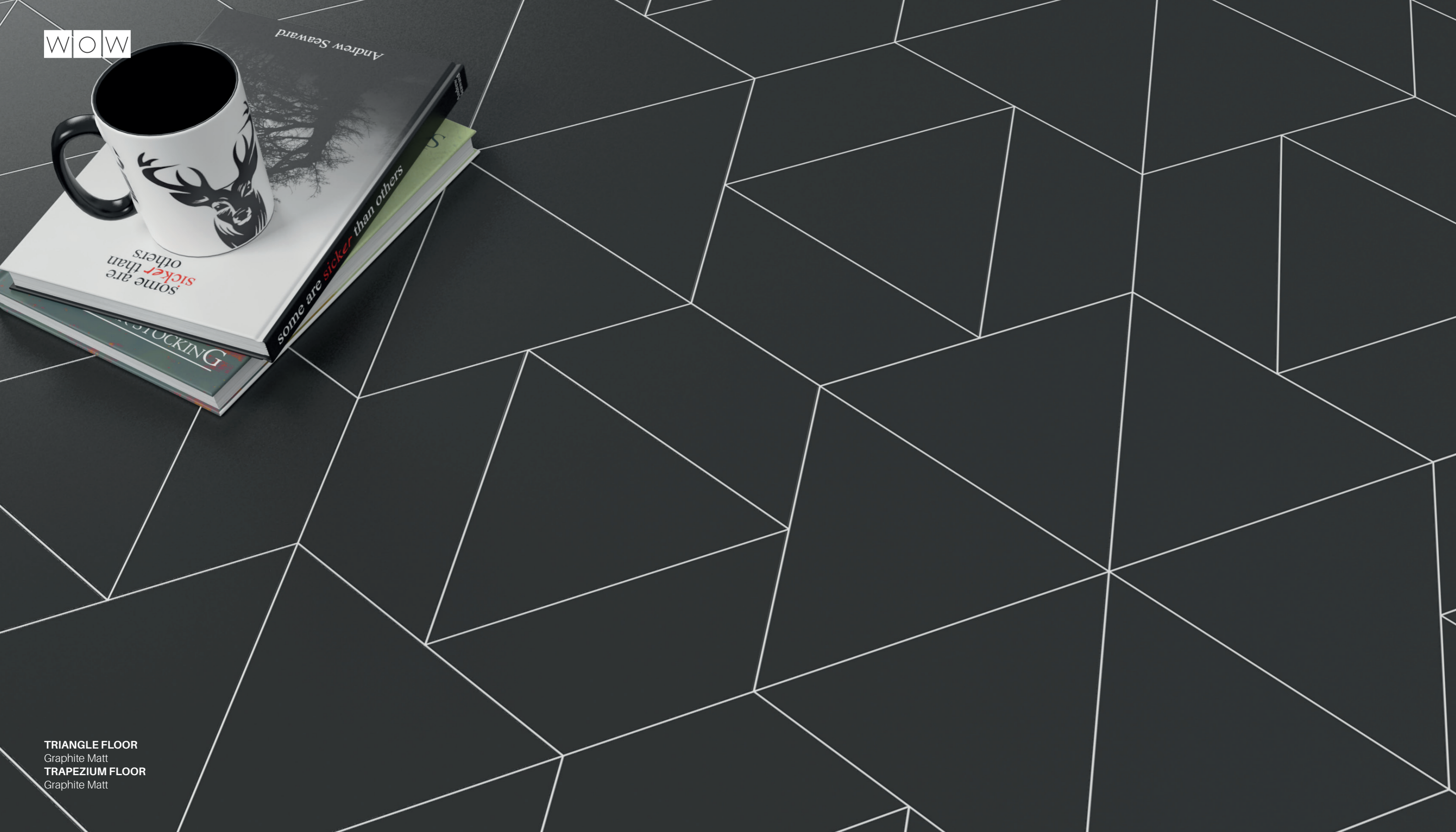

**TRIANGLE FLOOR**  
Graphite Matt  
**TRAPEZIUM FLOOR**  
Graphite Matt

**COMPOSITION**  
composición

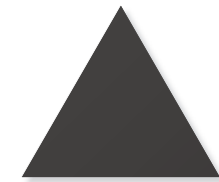

GRAPHITE MATT  
61 %



GRAPHITE MATT  
39 %





Floor:  
**HEXA FLOOR**  
Ice White Matt  
**TRIANGLE FLOOR**  
Ice White Matt

Wall:  
**NILO by WOW**  
Graphite Matt

**COMPOSITION**  
composición



ICE WHITE MATT  
57 %



ICE WHITE MATT  
43 %

**WALL TILE**  
composición

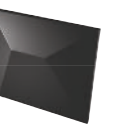

**NILO by WOW**  
GRAPHITE MATT





COMPOSITION  
composición



ICE WHITE MATT  
33,3 %

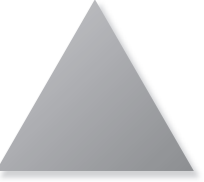

ASH GREY MATT  
33,3 %

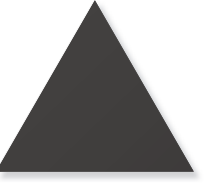

GRAPHITE MATT  
33,3 %

TRIANGLE FLOOR  
. Ice White Matt  
. Ash Grey Matt  
. Graphite Matt





COMPOSITION  
composición

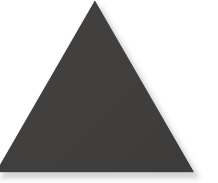

GRAPHITE MATT



ICE WHITE MATT  
61 %



ICE WHITE MATT  
39 %

Wall:  
TRIANGLE FLOOR  
Graphite Matt

Floor:  
TRIANGLE FLOOR  
Ice White Matt  
TRAPEZIUM FLOOR  
Ice White Matt



# HEXA FLOOR

8"X9" / 20X23 cm



Available colours / Colores disponibles



ICE WHITE MATT

ASH GREY MATT

GRAPHITE MATT







COMPOSITION  
composición

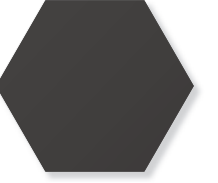

GRAPHITE MATT

WALL TILE  
composición



MOON by WOW  
ICE WHITE MATT

HEXA FLOOR  
Graphite Matt

Wall:  
MOON by WOW  
Ice White Matt





COMPOSITION  
composición



ICE WHITE MATT





COMPOSITION  
composición



ASH GREY MATT





COMPOSITION  
composición



ICE WHITE MATT



# TRAPEZIUM FLOOR

4"X9" / 10X23 cm

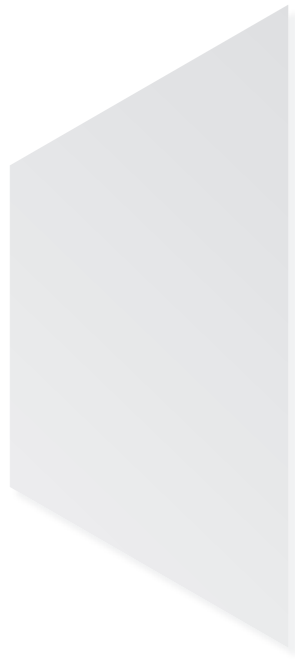

Available colours / Colores disponibles



ICE WHITE MATT



ASH GREY MATT



GRAPHITE MATT



**TRAPEZIUM FLOOR**  
Ice White Matt  
Ash Grey Matt  
Graphite Matt



COMPOSITION  
composición



ICE WHITE MATT



WOW



COMPOSITION  
composición



ASH GREY MATT





COMPOSITION  
composición



ICE WHITE MATT

WALL TILE  
composición



ARCH by WOW  
GRAPHITE MATT

TRAPEZIUM FLOOR  
Ice White Matt  
ARCH by WOW  
Graphite Matt



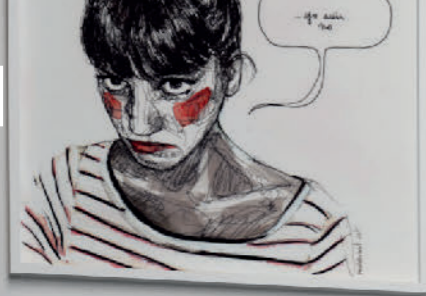

**TRAPEZIUM FLOOR**

Ice White Matt  
Ash Grey Matt  
Graphite Matt

**COMPOSITION**  
composición



ICE WHITE MATT  
42 %



ASH GREY MATT  
29 %



GRAPHITE MATT  
29 %

**WALL TILE**  
composición



HEXA by WOW  
ICE WHITE MATT





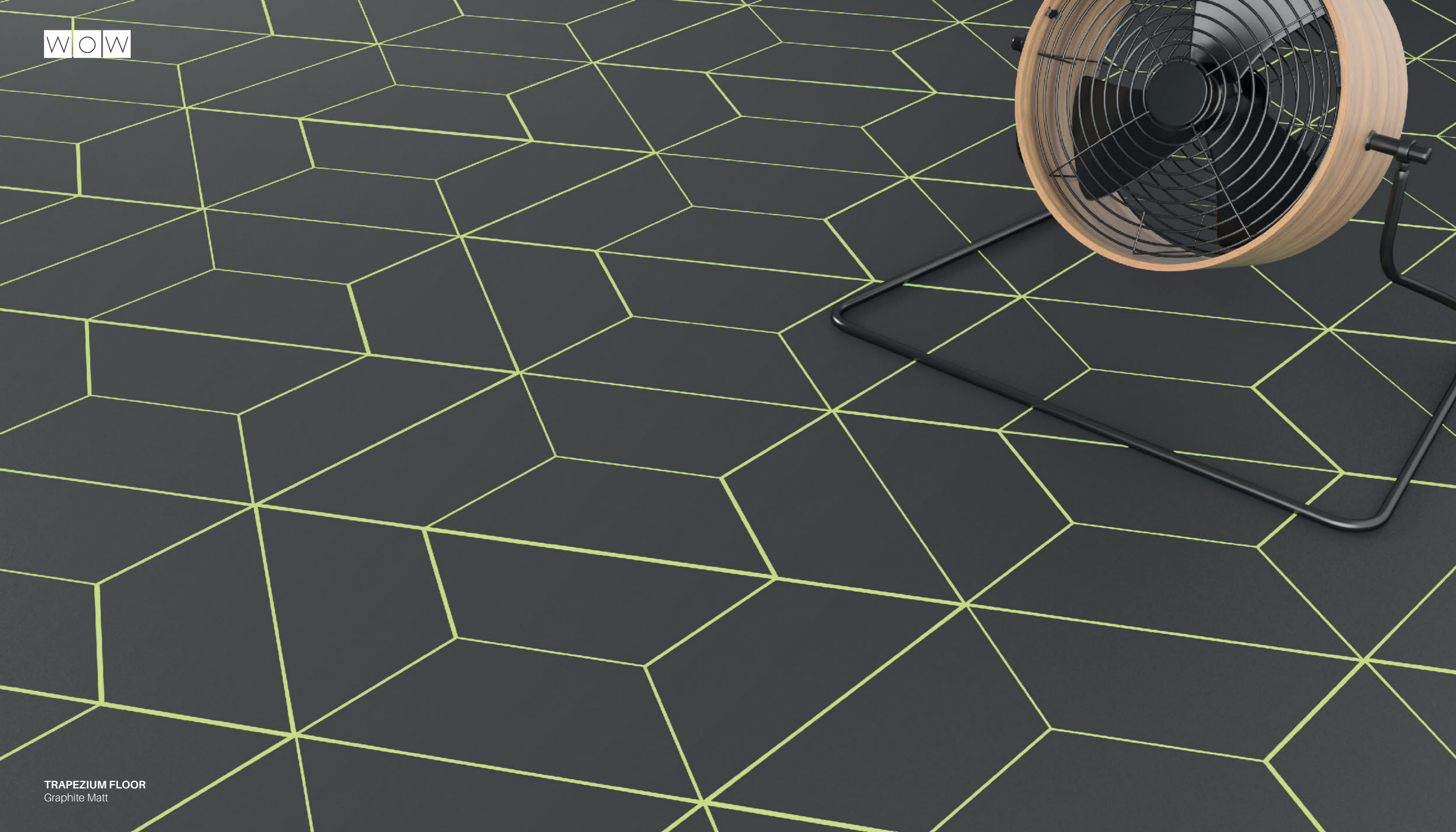

COMPOSITION  
composición



GRAPHITE MATT





COMPOSITION  
composición



ICE WHITE MATT  
70 %



ASH GREY MATT  
15 %



GRAPHITE MATT  
15 %

TRAPEZIUM FLOOR  
Ice White Matt  
Ash Grey Matt  
Graphite Matt



# CHEVRON FLOOR

4"X20,5" / 10X52 cm

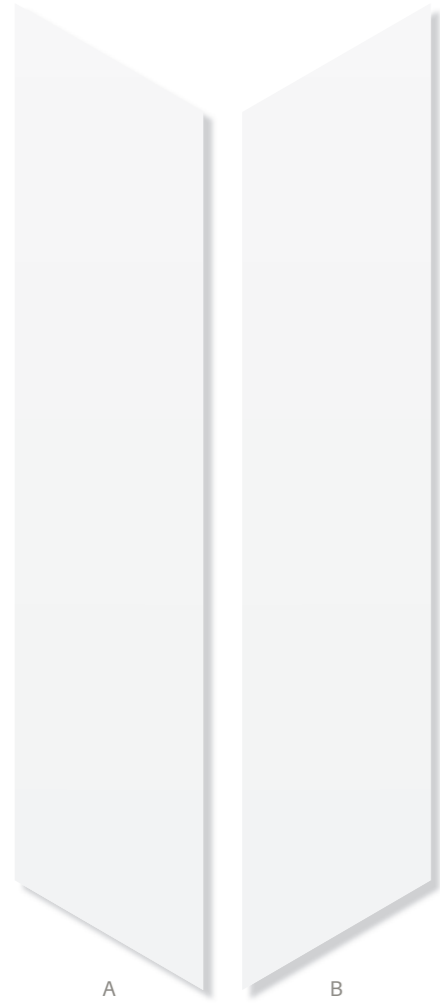

Available colours / Colores disponibles

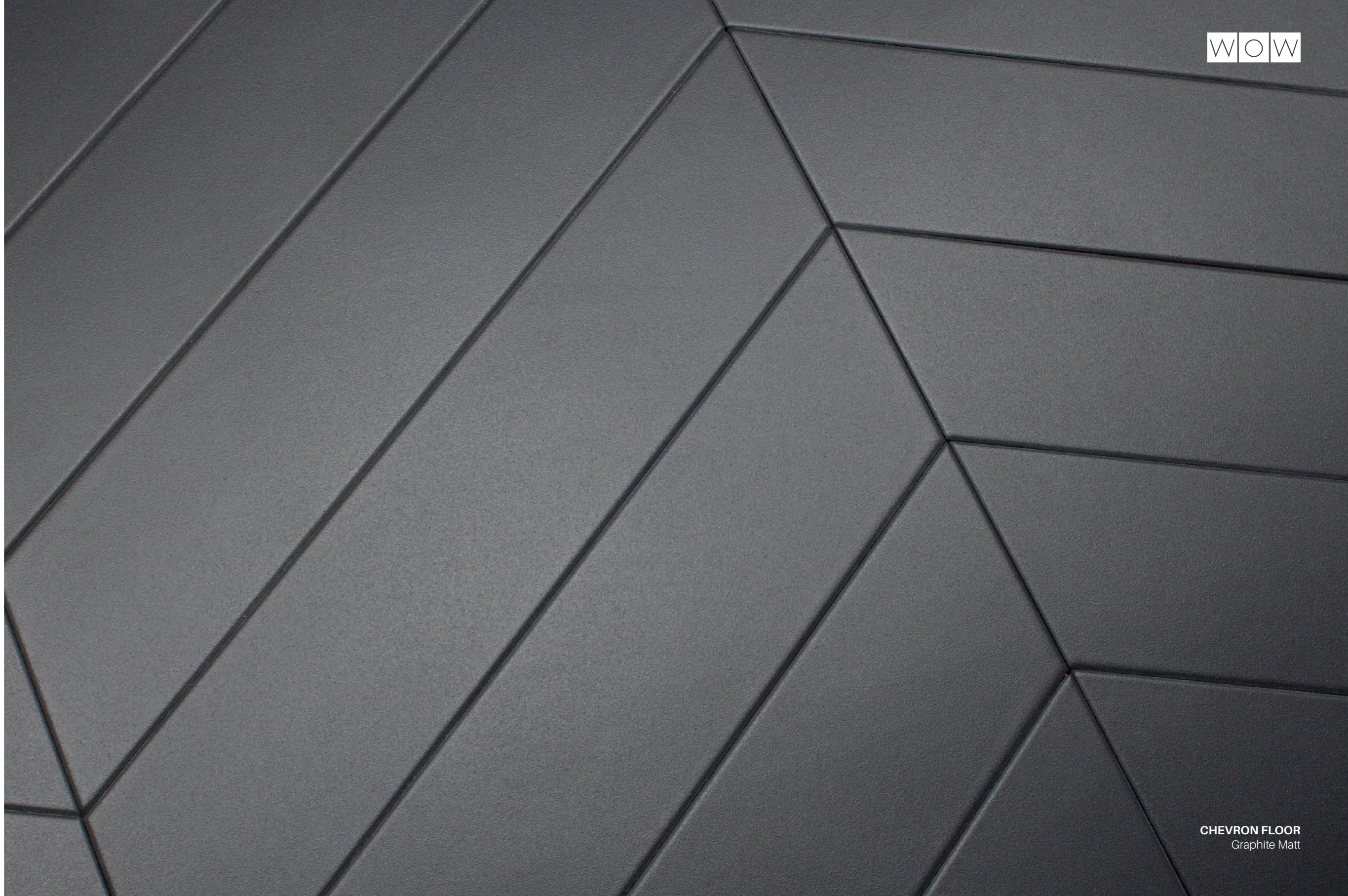
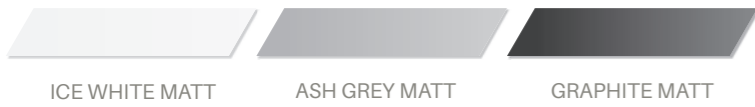





**COMPOSITION**  
composición

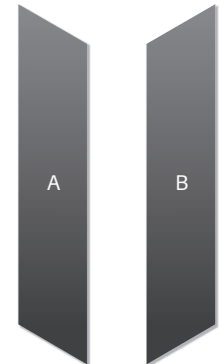

50 %      50 %  
GRAPHITE MATT

**WALL TILE**  
composición



**WAVE by WOW**  
ICE WHITE MATT

**Floor:**  
**CHEVRON FLOOR**  
Graphite Matt

**Wall:**  
**WAVE by WOW**  
Ice White Matt



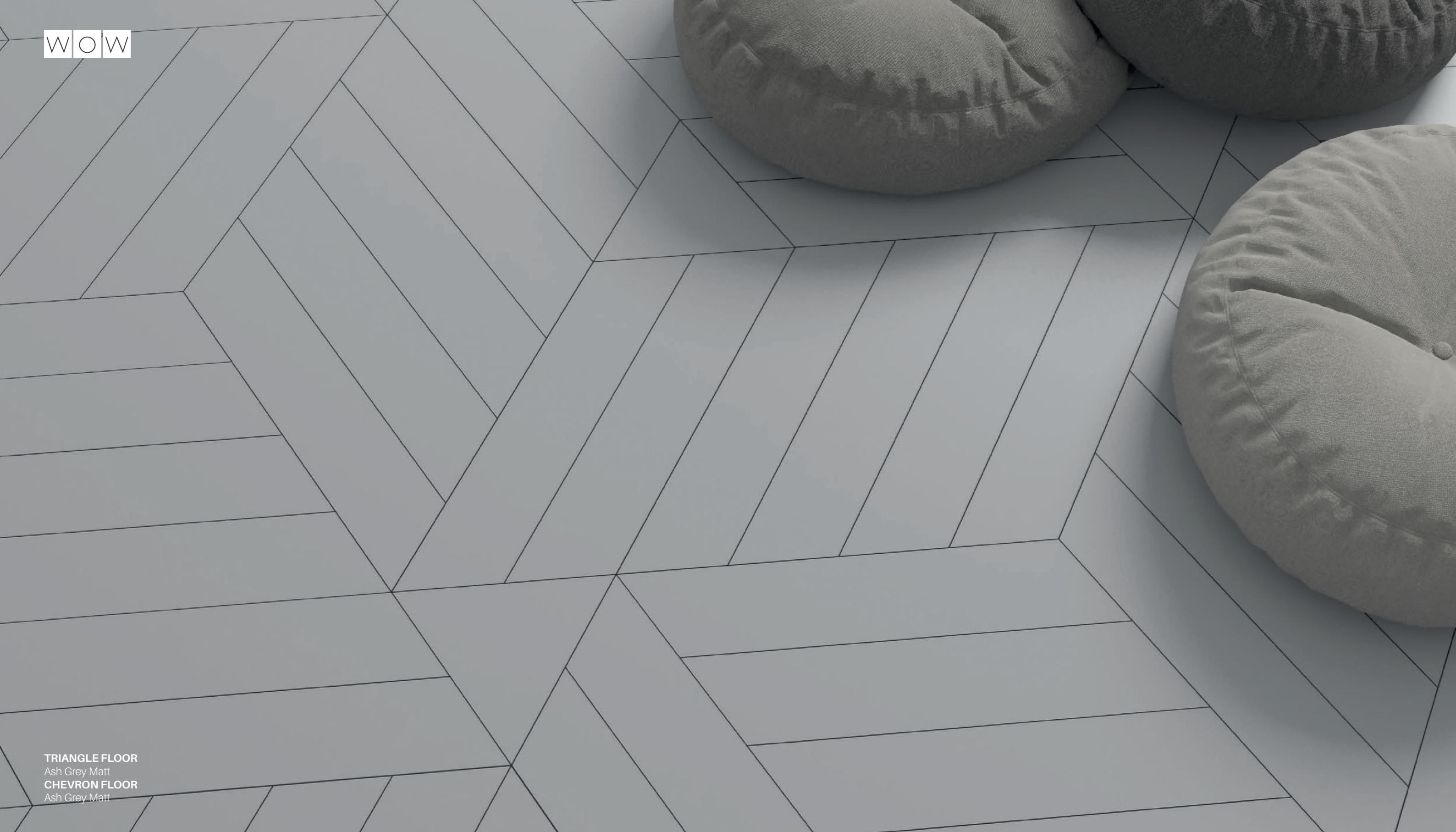

**COMPOSITION**  
composición

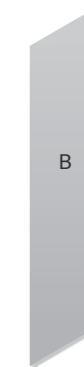

95 %  
ASH GREY MATT



ASH GREY MATT  
5 %

**TRIANGLE FLOOR**  
Ash Grey Matt  
**CHEVRON FLOOR**  
Ash Grey Matt





COMPOSITION  
composición



ICE WHITE MATT





CHEVRON FLOOR  
Ash Grey Matt

COMPOSITION  
composición

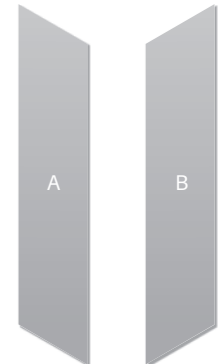

50 %      50 %  
ASH GREY MATT

WALL TILE  
composición



MOON L by WOW  
ICE WHITE MATT  
35 %



MOON by WOW  
ICE WHITE MATT  
65 %



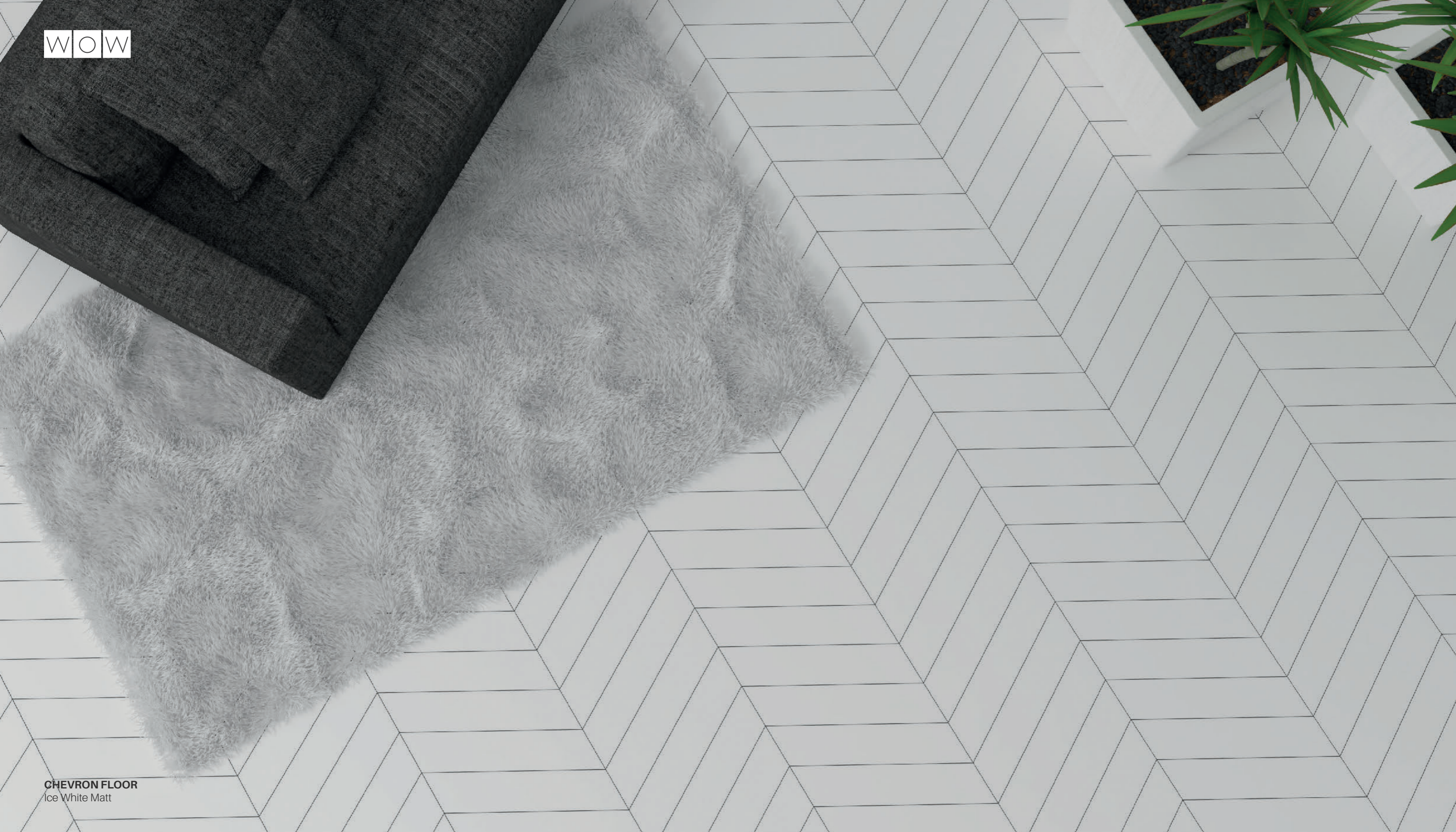

COMPOSITION  
composición

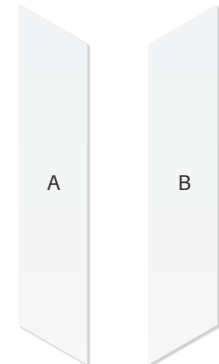

50%      50%  
ICE WHITE MATT

CHEVRON FLOOR  
Ice White Matt





COMPOSITION  
composición

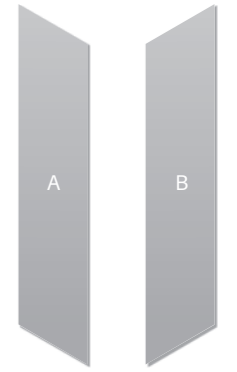

50%      50%  
ASH GREY MATT



ASH GREY MATT









**CHEVRON FLOOR**  
Ash Grey Matt  
**HEXA FLOOR**  
Ash Grey Matt



## FLOOR TILES, TECHNICAL FEATURES / INFORMACIÓN TÉCNICA

## FLOOR TILES, RECOMMENDATIONS / RECOMENDACIONES

TECHNICAL FEATURES FOR DRY-PRESSED CERAMIC TILES WITH WATER ABSORPTION B Ia ( $\leq 0,5\%$ )CARACTERÍSTICAS TÉCNICAS PARA LAS BALDOSAS CERÁMICAS PRENSADAS EN SECO CON ABSORCIÓN DE AGUA B Ia ( $\leq 0,5\%$ )

FEATURES / CARACTERÍSTICAS	SPECIFICATION / ESPECIFICACIÓN	NORMA
 Dimensional Features.	Triangle Floor (W 202 mm +/- 0,6% x 233 mm +/- 0,6% x 8,5 mm +/- 5%) GL Hexa Floor (W 200,5 mm +/- 0,6% x 231 mm +/- 0,6% x 8,5 mm +/- 5%) GL Trapezium Floor (W 99,5 mm +/- 0,9 mm x 229,5 mm +/- 0,6% x 8,5 mm +/- 5%) GL Chevron Floor (W 99,5 mm +/- 0,9 mm x 520,5 mm +/- 0,6% x 8,5 mm +/- 5%) GL	UNE-EN ISO 10545-2:1998
 Water absorption.	$\leq 0,5\%$	UNE-EN ISO 10545-3:1997
 Modulus of rupture and breaking strength.	Minimum 35 N/mm <sup>2</sup> Individual Minimum 32 N/mm <sup>2</sup>	UNE-EN ISO 10545-4:2012
 Craze resistance.	Pass	UNE-EN ISO 10545-11:1997
 Household products resistance.	GA	UNE-EN ISO 10545-13:1998
 Chemical resistance.	GHA	UNE-EN ISO 10545-13:1998
 Stain resistance.	5	UNE-EN ISO 10545-14:1998
 Frost resistance.	Pass	UNE-EN ISO 10545-12:1997
 Non-slip value.	R9 / CLASS 2 DCOF 0,60	DIN 51130:2014 ANSI A137.1:2012

## WAREHOUSING

In order to guarantee the characteristics of the finish the product must be kept in its original packaging until the time of fixing. If the product is likely to be stored for a long period of time it should be suitably covered.

## TILE FIXING

To ensure porcelain earthenware floor tiles adhere correctly to the surface, it is essential to use specific adhesive and grouting material. This must also be suitable for the environment they will have to withstand. Fitting with traditional mortars does not ensure good adhesion.

All types of joints must be planned and carried out correctly: structural, perimeter, expansion and installation joints. Fitting tiles without joints is not advisable from any technical point of view as this may lead to various problems. We recommend a minimum installation joint of 2 mm (0 5/64 in).

## MAINTENANCE AND CLEANING

Once the materials have been fitted, it is advisable to remove any remaining adhesive and grouting material by using a commercial descaling product designed especially for ceramic floor tiles, diluted with water. The descaling product must not remain in contact with the surface to be cleaned for more than 5 minutes. To check that the chosen cleaning product will not damage the paving, we recommend previously testing an area that is hidden or not easily seen, or testing a tile that has not been fitted.

As a general guideline, powder detergents should not be used, not wire wool or abrasive materials. Generally a sponge will be sufficient with warm water and liquid neutral soap. Then rinse with plenty of clean water.

## WARNING!

No claims will be accepted after materials have been installed.

## ALMACENAMIENTO

Para garantizar las características de su acabado, el producto debe mantenerse en su embalaje original hasta el momento de la colocación. Si el producto va a permanecer almacenado durante un largo periodo es conveniente hacerlo bajo cubierta.

## COLOCACIÓN

Para garantizar una buena adhesión al soporte es necesaria la utilización de materiales de agarre y de rejuntado para baldosas de gres porcelánico y adecuados al ambiente al que vayan a estar sometidos. La colocación con morteros tradicionales no garantiza una buena adhesión.

Deberán planificarse y ejecutarse correctamente todo tipo de juntas: estructurales, perimetrales, de dilatación y de colocación. La colocación sin juntas es desaconsejable desde cualquier punto de vista técnico, pudiendo ser el origen de diversas patologías. Se recomienda una junta de colocación de 2 mm.

## MANTENIMIENTO Y LIMPIEZA

Finalizada la puesta en obra se recomienda eliminar los restos de materiales de agarre y rejuntado con un desincrustante comercial diseñado expresamente para baldosas cerámicas, rebajado con agua, permaneciendo en contacto con la superficie a limpiar no más de 5 minutos. Para verificar que el limpiador escogido no dañará al pavimento se requiere hacer una prueba previa en una zona oculta o poco visible o en una baldosa sin instalar.

Como norma general no deben utilizarse detergentes en polvo ni estropajos metálicos o abrasivos. Generalmente será suficiente con una esponja, agua tibia y un jabón líquido neutro. Posteriormente aclarar con abundante agua limpia.

## ¡ATENCIÓN!

No se aceptarán reclamaciones una vez instalado el material.



# FLOOR TILES, DIMENSIONAL FEATURES / PLANIMETRÍA

Hexa Floor

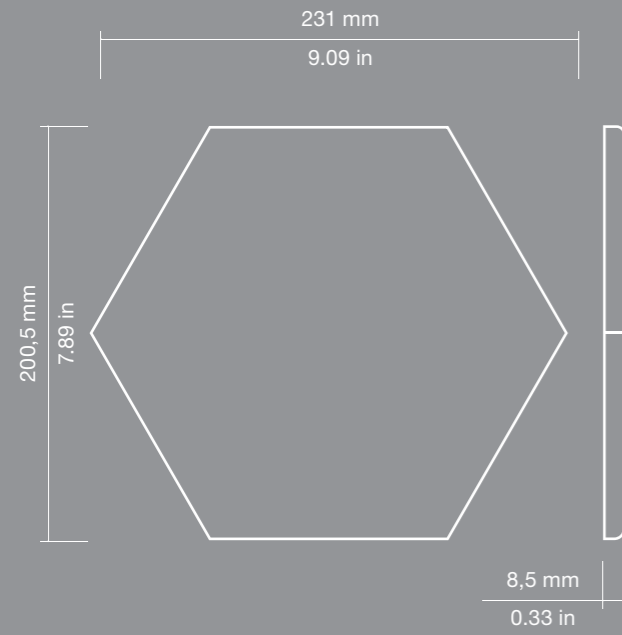

Triangle Floor

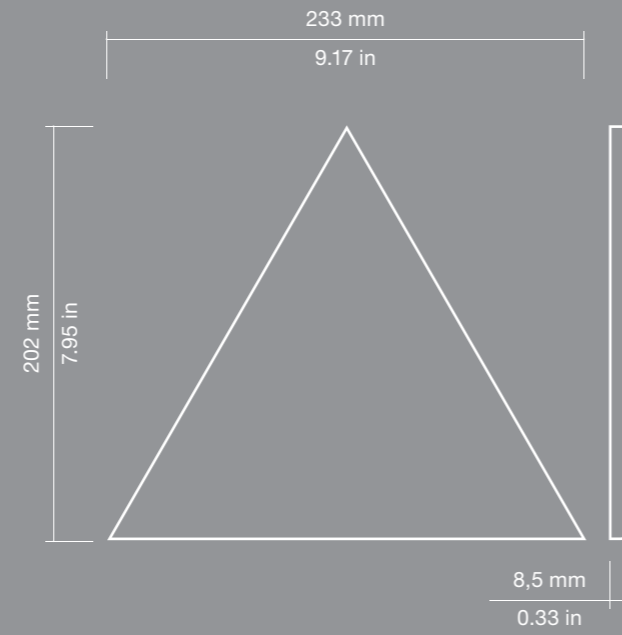

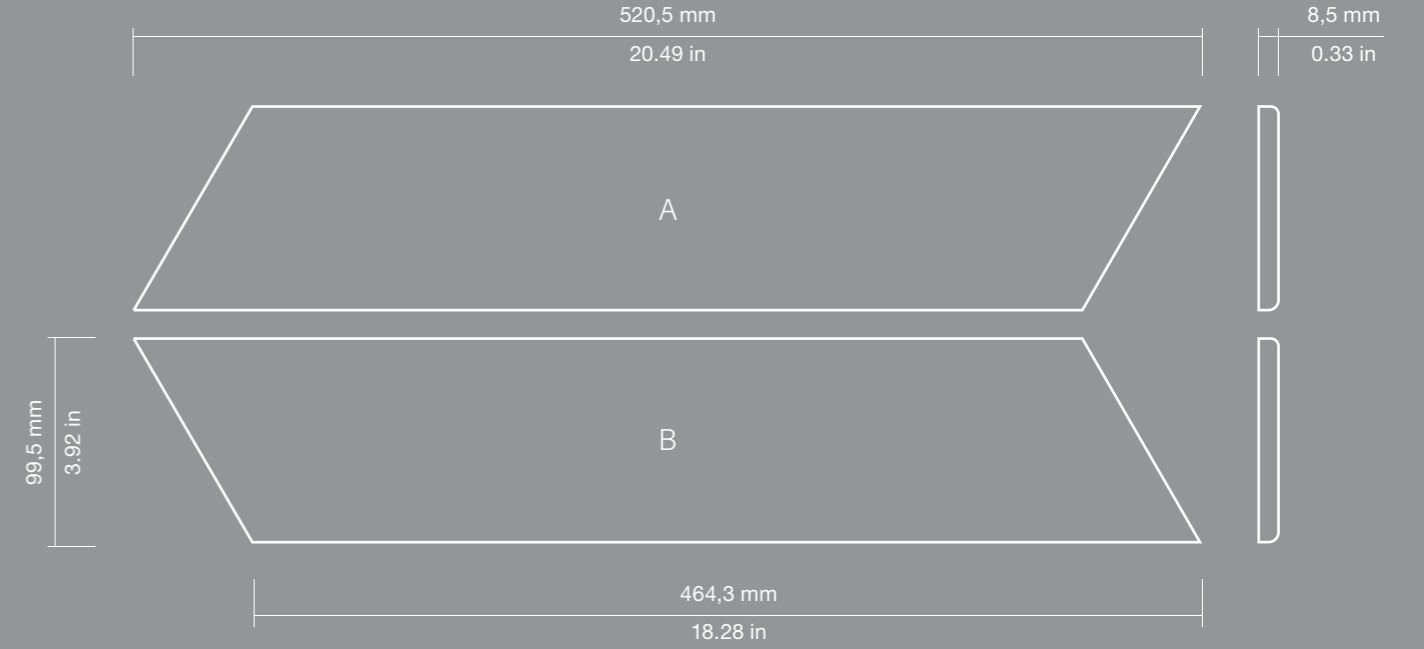

Chevron Floor

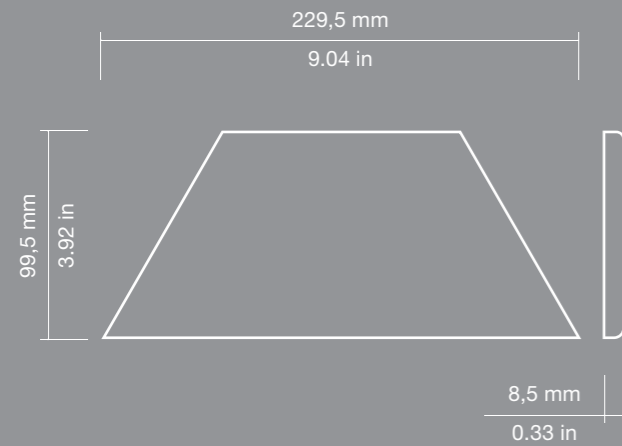

Trapezium Floor



## PACKING / ENCAJADO

Modelo Model	Piezas / Caja Pieces / Box	M2  FT2		KG  LB		Cajas / Palet Boxes / Pallet	M2  FT2	
		m2 / Caja	sq ft / Box	Kg / Caja	Lb/ box		m2 / Palet	sq ft / Pallet
TRIANGLE FLOOR	10	0,233 m2	2,508 sq ft	4,667 kg	10,289 lb	120	27,960 m2	300,960 sq ft
HEXA FLOOR	10	0,349 m2	3,757 sq ft	6,972 kg	15,371 lb	120	41,880 m2	450,840 sq ft
TRAPEZIUM FLOOR	20	0,334 m2	3,595 sq ft	6,932 kg	15,282 lb	120	40,080 m2	431,400 sq ft
CHEVRON FLOOR	10	0,456 m2	4,908 sq ft	8,640 kg	19,048 lb	112	51,072 m2	549,696 sq ft





©2018 Tendencias Cerámicas  
WOW, registered trademark of Tendencias Cerámicas, S.L.

The brand use or reproduction of the contents of this catalog, is protected by copyright law. Any use of the brand or reproduction thereof, in part or total, must be authorized by Tendencias Cerámicas, S.L. Otherwise, this action can be sanctioned according to the Law.

©2018 Tendencias Cerámicas  
WOW, marca registrada por Tendencias Cerámicas, S.L.

La utilización de la marca o la reproducción del contenido de este catálogo está protegida por la Ley de Propiedad Intelectual. Cualquier uso de la marca o la reproducción del mismo, en parte o en su totalidad, debe ser autorizada por Tendencias Cerámicas, S.L., pudiendo, en caso contrario, ser esta acción sancionada de acuerdo con la Ley.

WOW reserves the right to modify and/or discontinue certain models displayed in this catalogue.  
The colour of the pieces displayed herein may differ slightly from originals.  
The settings shown in this catalogue are design proposals for advertising purposes.  
In real situations in wich the pieces are laid, the installation instructions published by WOW should be followed.

WOW se reserva el derecho de modificar y/o suprimir ciertos modelos expuestos en este catálogo sin previo aviso.  
Los colores de las piezas pueden presentar ligeras diferencias respecto a las originales.  
Los ambientes que se muestran en este catálogo son sugerencias decorativas de carácter publicitario,  
debiéndose utilizar en la instalación real las instrucciones de colocación editadas por WOW.



Polígono Pont, Avda. de España 114  
12180 Cabanes,  
Castellón (Spain)  
t. +34 964 331 910 / f. +34 964 331 911

[www.wowdesigneu.com](http://www.wowdesigneu.com)  
[comercial@wowdesigneu.com](mailto:comercial@wowdesigneu.com)





Designed by

