

BLANC ET BLEU



WOW

BLANC ET BLEU

WOW

BLANC ET BLEU

From concept to reality

**How about versatile porcelain just as apt for your floors as for your walls?
Freedom of choice to install in any space, square shaped in 18,5x18,5 cm
(7"x7") size to dress any floor or wall.**

Blanc et Bleu, tribute to the artisan Spanish medieval technique.

**Brush strokes of cobalt blue pigment over a naturally aged white
background, where every single piece is unique.**

**Genuine reclaimed look, with the charm of authenticity and alluring
ornamental, geometrical and organic motifs.**

*¿Qué te parecerían porcelánicos versátiles y aptos tanto para uso en pavimento
como en revestimiento?*

*Libre elección para instalar en cualquier espacio, de medida 18,5x18,5cm (7"x7"),
perfectos para revestir cualquier suelo o pared.*

Blanc et Bleu, homenaje a la técnica medieval de los artesanos españoles.

*Pinceladas de azul cobalto sobre un fondo blanco naturalmente envejecido,
donde cada pieza es única.*

*Verdadera apariencia tradicional con el encanto y la autenticidad de unos motivos
ornamentales, geométricos y orgánicos.*

BLANC ET BLEU

Product introduction / Introducción de productos

7"x7" / 18,5x18,5 cm - Porcelain body

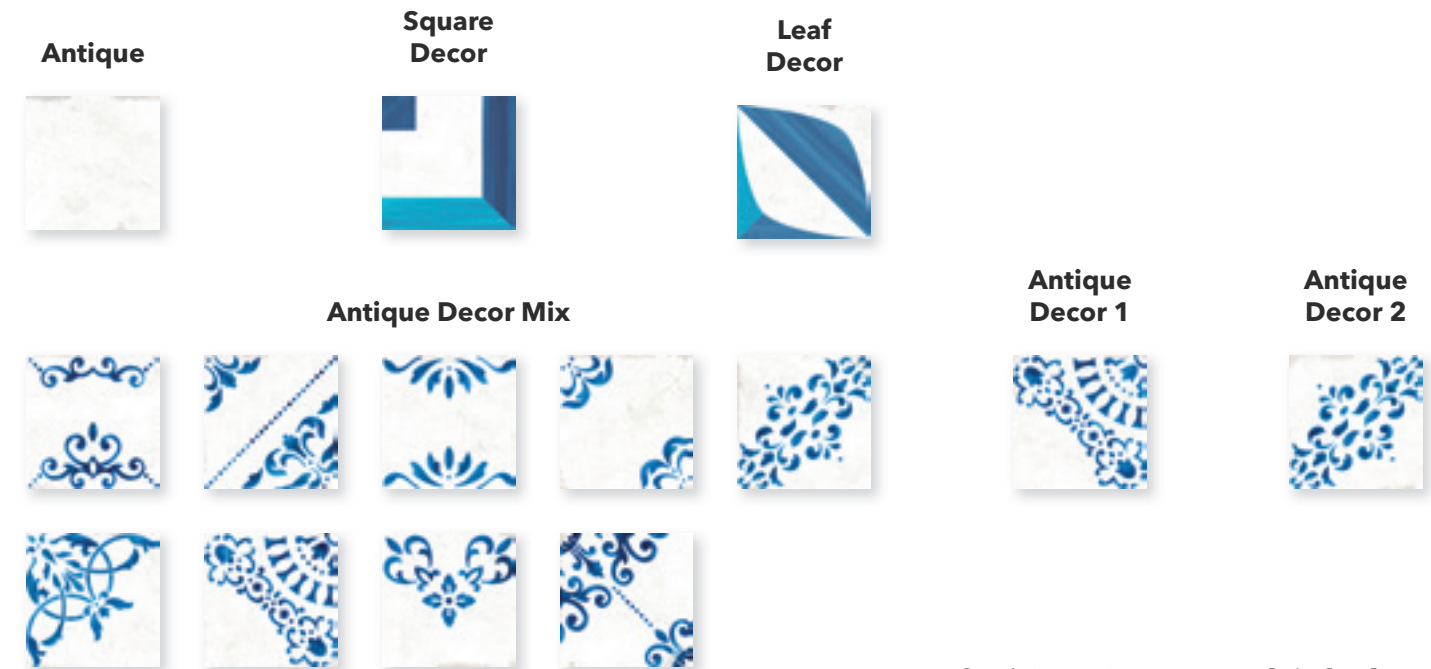

*(9 different patterns randomly mixed within the box /
9 diseños diferentes encajados aleatoriamente)*

1.5"x9" / 4x22,6 cm - Porcelain body

Crayon Blanc

Crayon Bleu



0.3"x5" / 0,8x12,5 cm - White body

0.3"x0.3" / 0,8x0,8 cm - White body

Edge Antique

Edge Corner Antique



Wall tile 5"x5" / 12,5x12,5 cm - White body

**Antique
wall**

**Square
wall decor**

**Leaf
wall decor**





ANTIQUE
7"x7" / 18,5x18,5 cm

06



SQUARE DECOR
7"x7" / 18,5x18,5 cm

08



LEAF DECOR
7"x7" / 18,5x18,5 cm

12



**ANTIQUE DECOR MIX /
ANTIQUE DECOR 1&2**
7"x7" / 18,5x18,5 cm

16



ANTIQUE WALL
5"x5" / 12,5x12,5 cm

28



EDGE ANTIQUE
0,43"x5" / 1,1x12,5 cm

30



SQUARE WALL DECOR
5"x5" / 12,5x12,5 cm

32



LEAF WALL DECOR
5"x5" / 12,5x12,5 cm

34

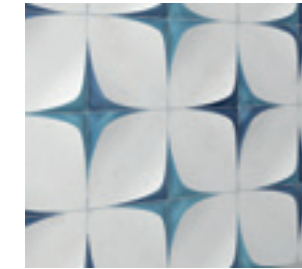

CRAYON
1.5"x9" / 4x22,6 cm

38



LAYOUT EXAMPLES
Ejemplos de colocación

42



TECHNICAL FEATURES
Características técnicas

45

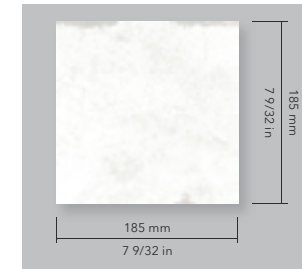

ANTIQUE

7" x 7" / 18,5x18,5 cm

Available colours

Colores disponibles

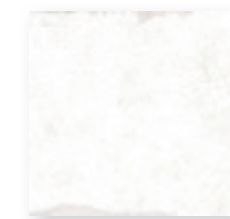

SQUARE DECOR

7" x 7" / 18,5x18,5 cm

Available colours

Colores disponibles





ANTIQUE
SQUARE DECOR



Square Decor
50%

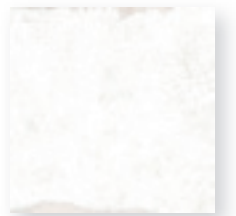

Antique
50%

Composition
Composición

LEAF DECOR

7" · 7" / 18,5 · 18,5 cm

Available colours

Colores disponibles





ANTIQUÉ
LEAF DECOR



Leaf Decor
40%

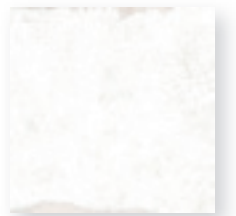

Antique
60%

Composition
Composición

ANTIQUE DECOR MIX

7" · 7" / 18,5 · 18,5 cm

Available colours

Colores disponibles





ANTIQUE DECOR MIX
ANTIQUE BLANC



Antique Decor Mix



Antique

ANTIQUE DECOR 1

7"x7" / 18,5x18,5 cm

Available colours

Colores disponibles





ANTIQUE DECOR 1



Antique Decor 1

ANTIQUE DECOR 2

7"x7" / 18,5x18,5 cm

Available colours

Colores disponibles





ANTIQUE DECOR 2



Antique Decor 2

ANTIQUÉ WALL

5" x 5" / 12,5x12,5 cm

Available colours

Colores disponibles



EDGE ANTIQUE

0,3"x5" / 0,8x12,5 cm



SQUARE WALL DECOR

5" x 5" / 12,5x12,5 cm

Available colours

Colores disponibles



ANTIQUE WALL

LEAF WALL DECOR

5" x 5" / 12,5x12,5 cm

Available colours

Colores disponibles

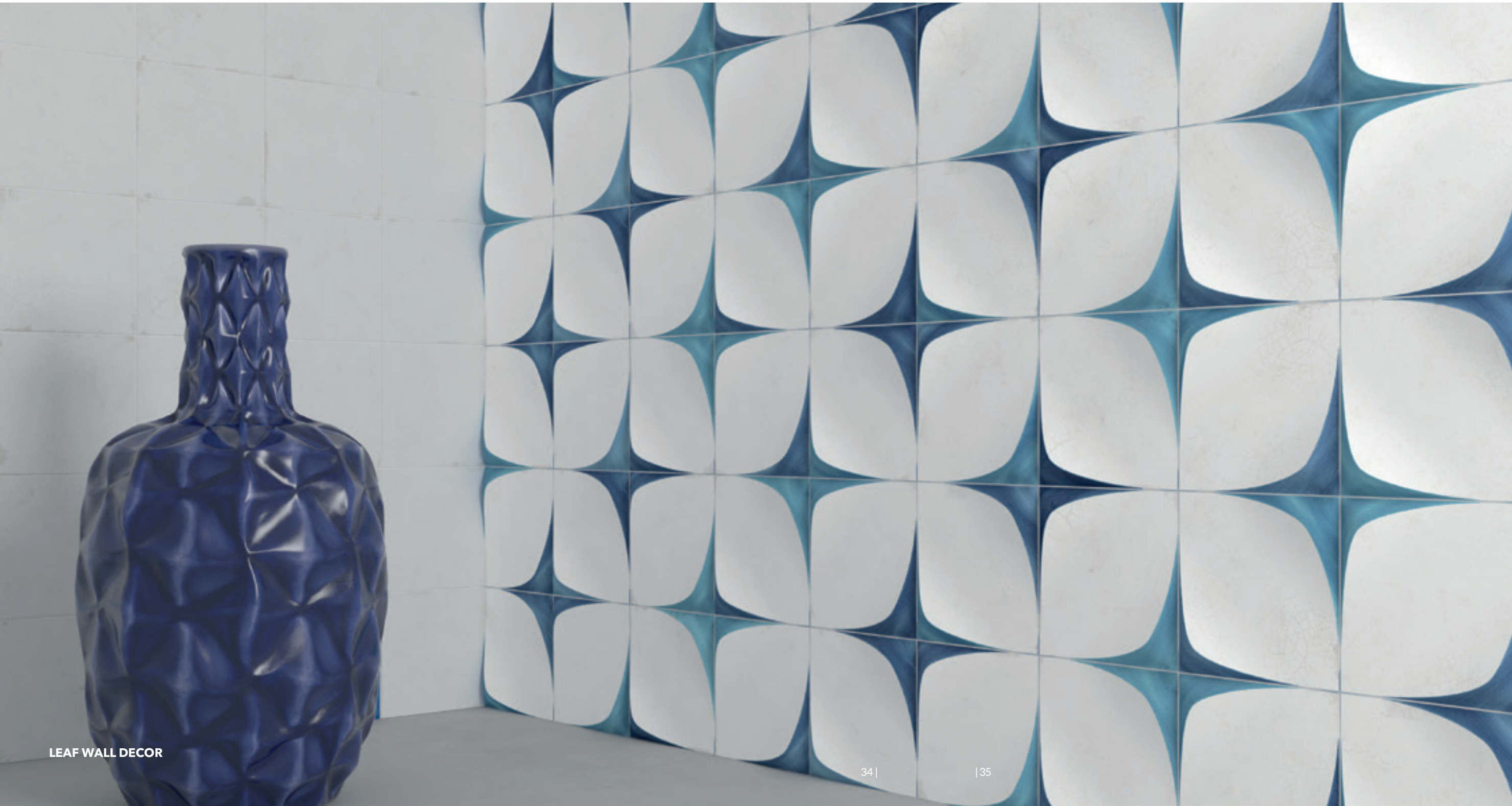



LEAF WALL DECOR



Leaf Wall Decor

BLANC ET BLEU CRAYON

1.5"x9" / 4x22,6 cm

Available colours

Colores disponibles

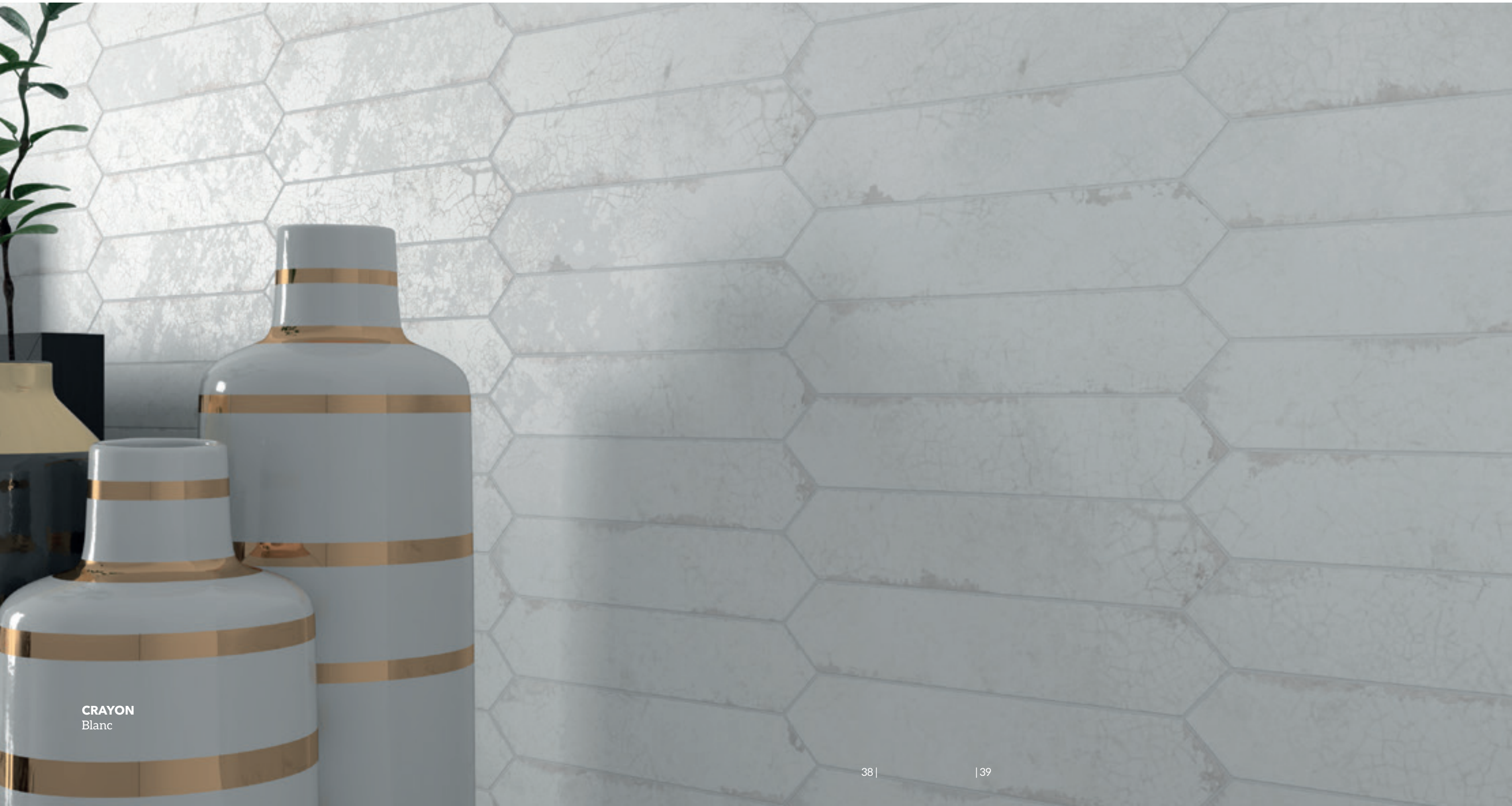

Blanc



Bleu

CRAYON
Blanc



BLANC ET BLEU CRAYON
Bleu
ANTIQUE



Bleu

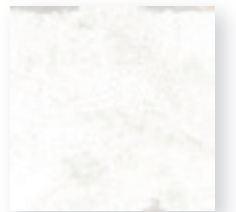

Antique

Crayon & Antique



n° 1

Crayon Bleu

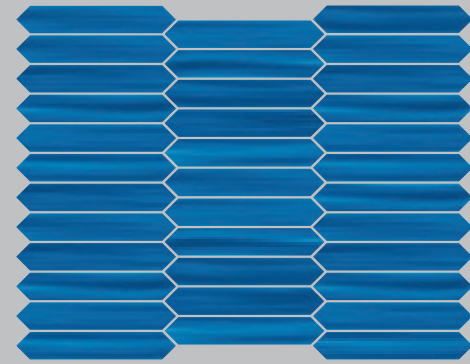

n° 2

Crayon Blanc



n° 1

Crayon Blanc & Leaf Decor

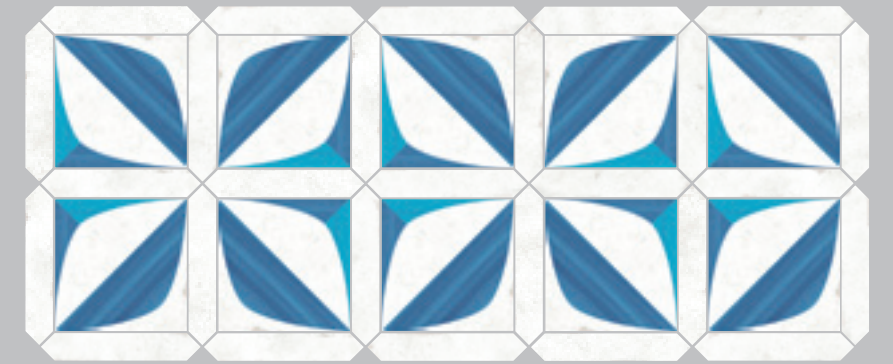

n° 2

Square Decor

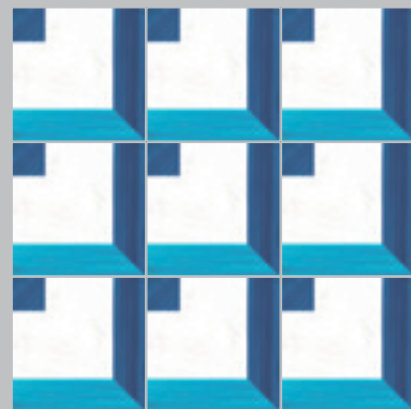

n° 1



n° 2



n° 3

Leaf Decor

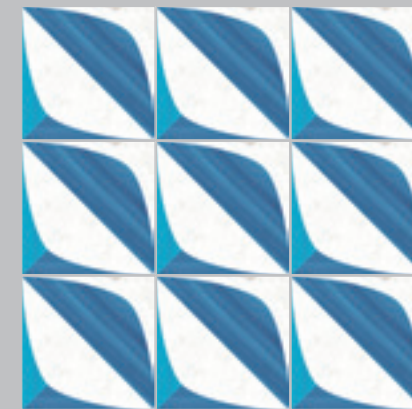

n° 1

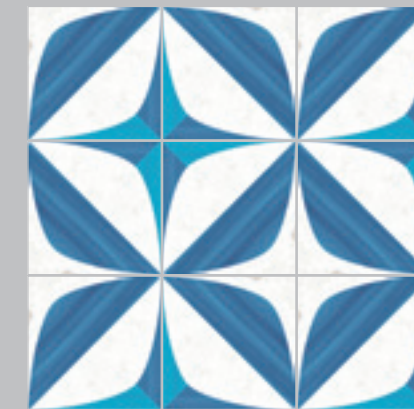

n° 2

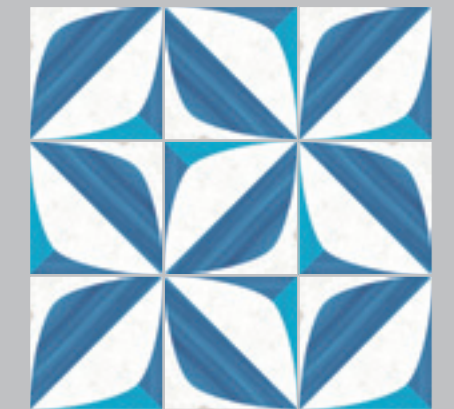

n° 3

Antique Decor Mix



n° 1 (random)

Antique Decor 1



n° 1

Antique Decor 1



n° 2

Antique Decor 2



n° 1

Antique Decor 2



n° 2

FLOOR TILE

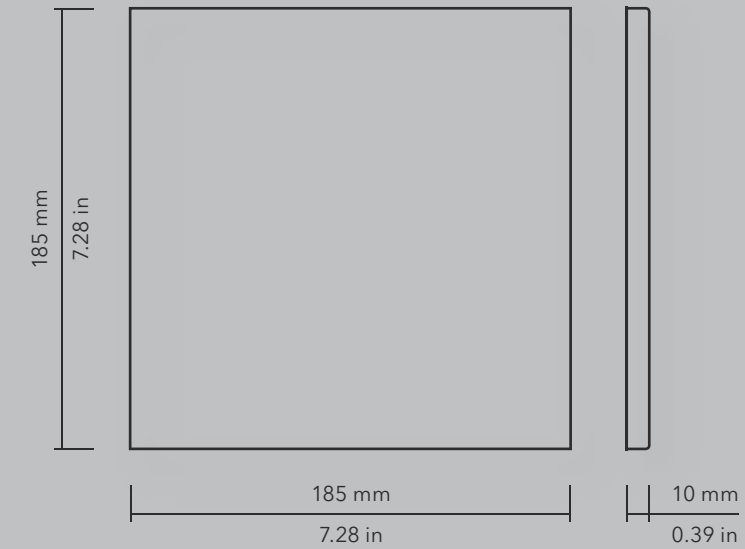

WALL TILES

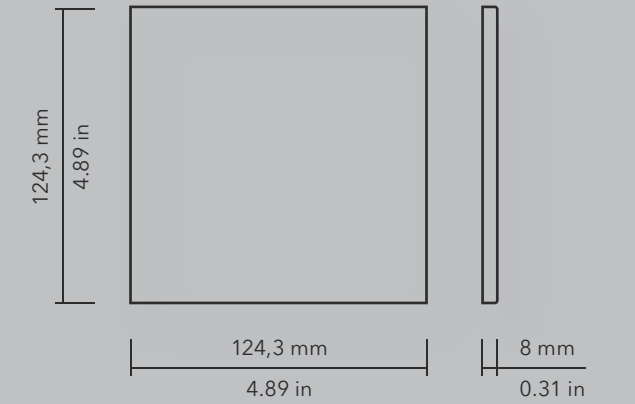

BLANC ET BLEU CRAYON

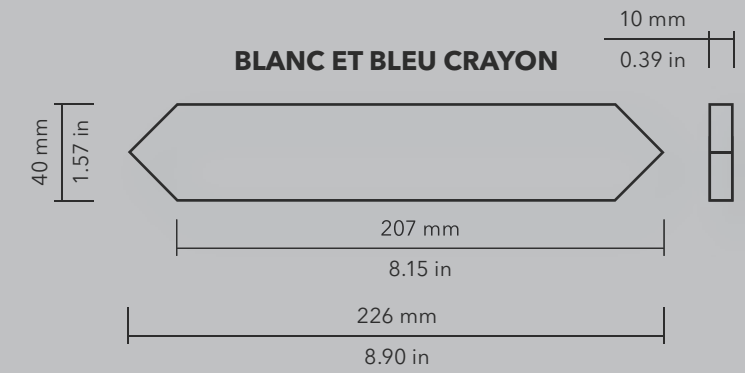

WAVE WALL DECOR

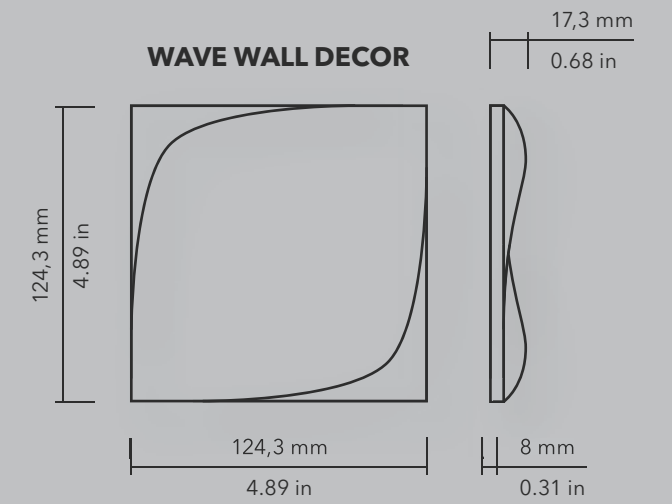

EDGE ANTIQUE

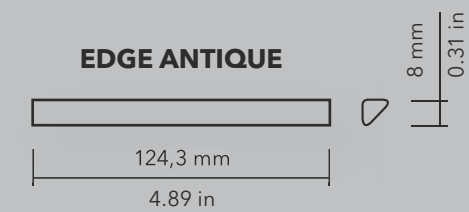

EDGE CORNER ANTIQUE

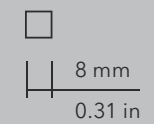

Model	Size (in)	Pieces/box	lb/box	sq ft/box	Box/pallet	sq ft/pallet
Antique	7"x7"	12	19.605 lb	4.445 sq ft	108	480.060 sq ft
Square Decor	7"x7"	12	19.605 lb	4.445 sq ft	108	480.060 sq ft
Leaf Decor	7"x7"	12	19.605 lb	4.445 sq ft	108	480.060 sq ft
Antique Decor Mix	7"x7"	12	19.605 lb	4.445 sq ft	108	480.060 sq ft
Antique Decor 1	7"x7"	12	19.605 lb	4.445 sq ft	108	480.060 sq ft
Antique Decor 2	7"x7"	12	19.605 lb	4.445 sq ft	108	480.060 sq ft
Blanc et Bleu Crayon	1.5"x9"	46	18.907 lb	4.123 sq ft	90	371.070 sq ft
Atinque Wall	5"x5"	38	19.745 lb	6.318 sq ft	102	644.436 sq ft
Square Wall Decor	5"x5"	38	19.745 lb	6.318 sq ft	102	644.436 sq ft
Leaf Wall Decor	5"x5"	27	14.824 lb	4.489 sq ft	102	457.878 sq ft
Edge Antique	0.3"x5"	10	0.551 lb	4.068 Lft	-	-
Edge Corner Antique	0.3"x0.3"	-	-	-	-	-

Modelo Model	Tamaño (cm) Size (cm)	Piezas/caja Pieces/box	Kg/caja kg/box	m²/caja m²/box	Cajas/palet Box/pallet	m²/palet m²/pallet
Antique	18,5x18,5 cm	12	8,893 kg	0,413 m²	108	44,604 m²
Square Decor	18,5x18,5 cm	12	8,893 kg	0,413 m²	108	44,604 m²
Leaf Decor	18,5x18,5 cm	12	8,893 kg	0,413 m²	108	44,604 m²
Antique Decor Mix	18,5x18,5 cm	12	8,893 kg	0,413 m²	108	44,604 m²
Antique Decor 1	18,5x18,5 cm	12	8,893 kg	0,413 m²	108	44,604 m²
Antique Decor 2	18,5x18,5 cm	12	8,893 kg	0,413 m²	108	44,604 m²
Blanc et Bleu Crayon	4x22,6 cm	46	8,576 kg	0,383 m²	90	34,470 m²
Atinque Wall	12,5x12,5 cm	38	8,956 kg	0,587 m²	102	59,874 m²
Square Wall Decor	12,5x12,5 cm	38	8,956 kg	0,587 m²	102	59,874 m²
Leaf Wall Decor	12,5x12,5 cm	27	6,724 kg	0,417 m²	102	42,534 m²
Edge Antique	0,8x12,5 cm	10	0,250 kg	1,240 m	-	-
Edge Corner Antique	0,8x0,8 cm	-	-	-	-	-

Dry-pressed ceramic tiles with water absorption B la ≤ 0,5% for interior and exterior floors and walls.
 Baldosas cerámicas prensadas en seco con absorción de agua B la ≤ 0,5% para suelos y paredes interiores y exteriores.

FEATURES / CARACTERÍSTICAS	SPECIFICATION / ESPECIFICACIÓN	NORMA
Dimensional Features	186 mm +/- 0,6 % x 186 mm +/- 0,6 % 40 mm +/- 0,6 % x 226 mm +/- 0,6 %	UNE-EN ISO 10545-2:1998
Water absorption	$E_b \leq 0,5\%$	UNE-EN ISO 10545-3:1997
Modulus of rupture and breaking strength	Minimum 35 N/mm ² Individual Minimum 32 N/mm ²	UNE-EN ISO 10545-4:2012
Abrasive resistance	3 - 4 According to model	UNE-EN ISO 10545-7:1999
Crazing resistance	Pass	UNE-EN ISO 10545-11:1997
Frost resistance	Pass	UNE-EN ISO 10545-11:1997
Household products resistance	GA	UNE-EN ISO 10545-13:1998
Chemical resistance	GLA	UNE-EN ISO 10545-13:1998
Stain resistance	>3	UNE-EN ISO 10545-14:1998
Non-slip value	R9 / CLASS 2 DCOF >0,50	DIN 51130:2014 ANSI A137.1:2012

Technical features for Dry-Pressed ceramic tiles with water absorption BIII (Eb >10%)
 Características técnicas para las baldosas cerámicas prensadas en seco del grupo BIII (Eb >10%)

FEATURES / CARACTERÍSTICAS	SPECIFICATION / ESPECIFICACIÓN	NORMA
Dimensional Features	124,3 mm +/- 0,5 % x 124,3 mm +/- 0,5 %	UNE-EN ISO 10545-2:1998
Water absorption	$E_b > 10\%$	UNE-EN ISO 10545-3:1997
Modulus of rupture and breaking strength	Thickness ≤ 7,5 mm mínimo 15 N/mm ² Thickness > 7,5 mm mínimo 12 N/mm ²	UNE-EN ISO 10545-4:2012
Crazing resistance	Pass	UNE-EN ISO 10545-11:1997
Household products resistance	GA	UNE-EN ISO 10545-13:1998
Chemical resistance	GLA	UNE-EN ISO 10545-13:1998
Stain resistance	Class 5	UNE-EN ISO 10545-14:1998

WAREHOUSING

In order to guarantee the characteristics of the finish the product must be kept in its original packaging until the time of fixing. If the product is likely to be stored for a long period of time it should be suitably covered.

TILE FIXING

To ensure the products adhere correctly to the surface, it is essential to use specific adhesive and grouting material. This must also be suitable for the environment they will have to withstand. Fitting with traditional mortars does not ensure good adhesion.

Due to the nature of the material there may be dimensional variations between pieces. Therefore, all types of joints must be planned and carried out correctly: structural, perimeter, expansion and installation joints. Fitting tiles without joints is not advisable from any technical point of view as this may lead to various problems. For an optimal result, we advise to use 2 mm (0 5/64 in) grout.

MAINTENANCE AND CLEANING

Once the materials have been fitted, it is advisable to remove any remaining adhesive and grouting material by using a commercial descaling product designed especially, diluted with water. The descaling product must not remain in contact with the surface to be cleaned for more than 5 minutes.

As a general guideline, powder detergents should not be used, not wire wool or abrasive materials. Generally a sponge will be sufficient with warm water and liquid neutral soap. Then rinse with plenty of clean water.

ALMACENAMIENTO

Para garantizar las características de su acabado, el producto debe mantenerse en su embalaje original hasta el momento de la colocación. Si el producto va a permanecer almacenado durante un largo periodo es conveniente hacerlo bajo cubierta.

COLOCACIÓN

Para garantizar una buena adhesión al soporte es necesaria la utilización de materiales de agarre y de rejuntado adecuados al ambiente al que vayan a estar sometidos. La colocación con morteros tradicionales no garantiza una buena adhesión.

Debido a la naturaleza del material pueden existir diferencias dimensionales entre piezas. Por ello deberán planificarse y ejecutarse correctamente todo tipo de juntas: estructurales, perimetrales, de dilatación y de colocación. La colocación sin juntas es desaconsejable desde cualquier punto de vista técnico, pudiendo ser el origen de diversas patologías. Para un resultado óptimo, recomendamos usar 2 mm de junta.

MANTENIMIENTO Y LIMPIEZA

Finalizada la puesta en obra se recomienda eliminar los restos de materiales de agarre y rejuntado con un desincrustante comercial diseñado expresamente para baldosas cerámicas, rebajado con agua, permaneciendo en contacto con la superficie a limpiar no más de 5 minutos.

Como norma general no deben utilizarse detergentes en polvo ni estropajos metálicos o abrasivos. Generalmente será suficiente con una esponja, agua tibia y un jabón líquido neutro. Posteriormente aclarar con abundante agua limpia.

©2017 Tendencias Cerámicas

WOW, registered trademark of Tendencias Cerámicas, S.L.

The brand use or reproduction of the contents of this catalog, is protected by copyright law. Any use of the brand or reproduction thereof, in part or total, must be authorized by Tendencias Cerámicas, S.L. Otherwise, this action can be sanctioned according to the Law.

©2017 Tendencias Cerámicas

WOW, marca registrada por Tendencias Cerámicas, S.L.

La utilización de la marca o la reproducción del contenido de este catálogo está protegida por la Ley de Propiedad Intelectual. Cualquier uso de la marca o la reproducción del mismo, en parte o en su totalidad, debe ser autorizada por Tendencias Cerámicas, S.L., pudiendo, en caso contrario, ser esta acción sancionada de acuerdo con la Ley.

WOW reserves the right to modify and/or discontinue certain models displayed in this catalogue. The colour of the pieces displayed herein may differ slightly from originals.

The settings shown in this catalogue are design proposals for advertising purposes.

In real situations in which the pieces are laid, the installation instructions published by WOW should be followed.

WOW se reserva el derecho de modificar y/o suprimir ciertos modelos expuestos en este catálogo sin previo aviso.

Los colores de las piezas pueden presentar ligeras diferencias respecto a las originales.

Los ambientes que se muestran en este catálogo son sugerencias decorativas de carácter publicitario,

debiéndose utilizar en la instalación real las instrucciones de colocación editadas por WOW.

Designed by



Polígono Pont, Avda. de España 114
12180 Cabanes,
Castellón (Spain)
t. +34 964 331 910 / f. +34 964 331 911

wowdesigneu.com

info@wowdesigneu.com
comercial@wowdesigneu.com

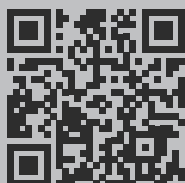

©2017 Tendencias Cerámicas

WOW, registered trademark of Tendencias Cerámicas, S.L.

The brand use or reproduction of the contents of this catalog, is protected by copyright law. Any use of the brand or reproduction thereof, in part or total, must be authorized by Tendencias Cerámicas, S.L. Otherwise, this action can be sanctioned according to the Law.

©2017 Tendencias Cerámicas

WOW, marca registrada por Tendencias Cerámicas, S.L.

La utilización de la marca o la reproducción del contenido de este catálogo está protegida por la Ley de Propiedad Intelectual. Cualquier uso de la marca o la reproducción del mismo, en parte o en su totalidad, debe ser autorizada por Tendencias Cerámicas, S.L., pudiendo, en caso contrario, ser esta acción sancionada de acuerdo con la Ley.

WOW reserves the right to modify and/or discontinue certain models displayed in this catalogue.

The colour of the pieces displayed herein may differ slightly from originals.

The settings shown in this catalogue are design proposals for advertising purposes.

In real situations in which the pieces are laid, the installation instructions published by WOW should be followed.

WOW se reserva el derecho de modificar y/o suprimir ciertos modelos expuestos en este catálogo sin previo aviso.

Los colores de las piezas pueden presentar ligeras diferencias respecto a las originales.

Los ambientes que se muestran en este catálogo son sugerencias decorativas de carácter publicitario, debiéndose utilizar en la instalación real las instrucciones de colocación editadas por WOW.